

MK-SERIES GEN 1 CLOUD MANAGED SERVER QUICK START GUIDE

GETTING STARTED

1. Connect the network cable intended for remote connections to the Client Network Port.
-  **NOTE** The Camera Network Port is intended for use with a dedicated camera network.
2. Connect the supplied **keyboard** and **mouse** using the USB ports.
 3. Connect a **monitor** using the HDMI® or DVI ports.
 4. Plug the supplied **power cord** into the recorder and connect it to a power source.

SENSOR / RELAY CARD (OPTIONAL)

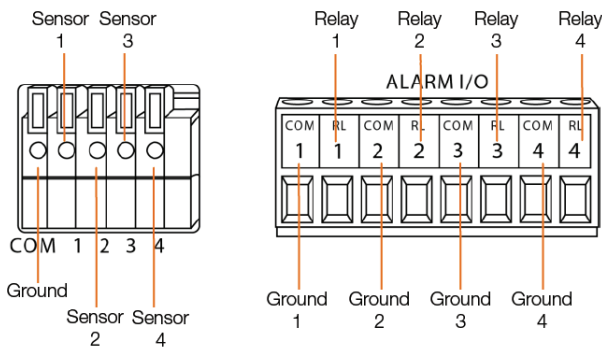

DEFAULT USERNAME & PASSWORD

WINDOWS USERS:

NVRAdmin

NVRUser

WINDOWS PASSWORD:

The server serial number is used as the default password for both accounts.

NOTE The serial number can be found on the product label located on the side of the server.

NOTE It is strongly recommended the password is changed during initial setup. See hardware manual for instructions.

APEX LOGIN:

Launch **Apex Server Home** from the desktop.

Log in to server software using default credentials:

Username: admin

Password: 1234

Complete the **First Time Wizard** for basic system setup.

REAR I/O CONNECTIONS

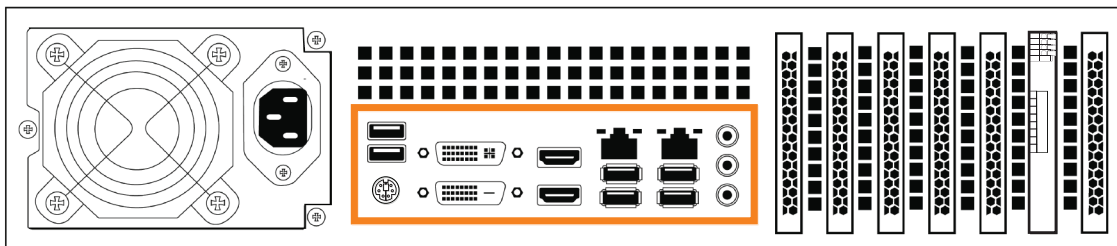
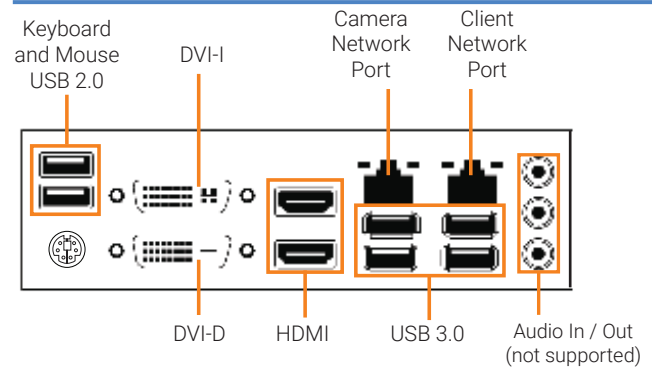

CONNECTING TO OPENEYE WEB SERVICES

1. Go to **Setup** , and then navigate to the **Remote Services** tab.
2. Click **Web Services**.
3. Enter the **Recorder Name & Registration Code**.



NOTE Reference the OWS Software Manual for instructions on finding your Recorder Registration Code.

4. Click **Connect**.

CAMERA MANAGEMENT

Apex Server software automatically detects OpenEye and other ONVIF Profile S compliant cameras with an IP address in the same range; 192.168.51.x.

Cameras not meeting these requirements must be configured manually.



NOTE Third party cameras may need to be configured using a third party program before being added to Apex Server. Cameras that don't support ONVIF can be configured to record via RTSP streaming.

Adding Cameras through the Camera Network Port

1. Click **Setup** , and then click **Cameras**.
2. Click **Add Cameras**.
3. For automatically detected cameras, select the camera(s) using the check boxes, and then type the appropriate **Username** and **Password**.
4. Click **Add Selected Cameras**.

Adding Cameras Manually

1. Click **Setup** , and then click **Add Cameras**.
2. Click **Manually Add a Camera**.

Network Settings

Remote Communication Port	80 (8888 used if 80 is blocked)
Client Network Port IP Address	DHCP
Camera Network Port (External Switch)	192.168.51.1 / 255.255.255.0 (Gateway and DNS blank)

3. Select the ONVIF or the RTSP protocol, and then type the appropriate **Username**, **Password**, **IP Address** and **Port**.
4. If you have more cameras to add manually, click **Save and Add New**; if you do not have more cameras to add, click **Save**.



NOTE When using RTSP, specify the individual URL streams for your cameras. For instructions regarding these streams, consult the camera manual.

Setting a Static IP Address with Network Camera Manager

1. Launch **Network Camera Manager** using the icon on the desktop.
2. Select which camera(s) you want to change from the current IP address to a static IP address.



NOTE Selecting multiple cameras will set a static IP on all cameras, starting at the IP address entered and increasing with each camera. If necessary, reference the Network Camera Manager User Manual for additional instructions.

3. Exit Network Camera Manager.
4. Follow the steps in the *Adding Cameras Manually* section, typing the **Static IP Address**.

Adding Third Party Cameras

Third party cameras may require installing a manufacturer camera discovery tool on a separate PC. Once the camera discovery tool is installed, follow the steps for adding a camera with a static IP address or using DHCP as outlined above.

Adding Cameras Not Supported by ONVIF

Cameras which are not ONVIF compliant must be added via RTSP stream. Consult the manufacturer's camera manual for more detailed information regarding RTSP streams. When you know the URL for the RTSP stream of your camera, follow the steps in the Adding Cameras Manually section, selecting RTSP protocol.