

CONNECTIONS

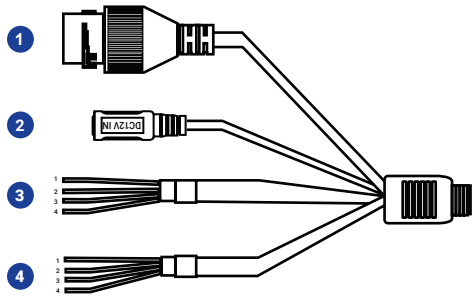

1	RJ-45	For network and PoE connections	
2	Power (12vDC)*	Power connection	
3	Audio I/O	Grey	Audio Out
		Purple	Ground
		Green	Audio In
		Brown	Ground
4	Alarm I/O	Yellow	Alarm Out +
		White	Alarm Out -
		Orange	Alarm Input
		Blue	Ground

*12vDC power input port should be plugged when not in use.

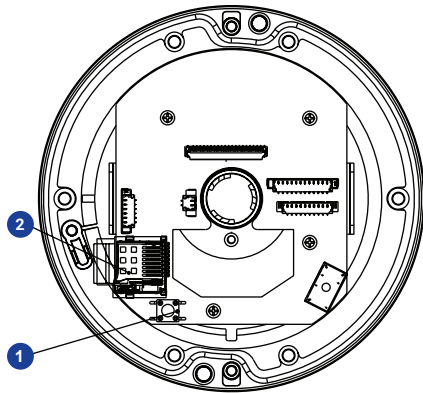

1	Reset Button	To restore the camera to factory defaults: 1. Disconnect power for 30 seconds. 2. Reconnect power and wait 30 seconds. 3. Press and hold the reset button for 20 seconds.
2	MicroSD Card Slot	Supports up to 512GB microSD card for Edge storage. Do not add or remove the microSD card when the camera is powered on.

Waterproof Cable

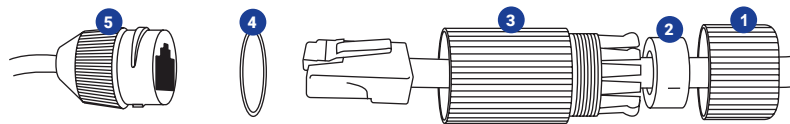

1	Thread lock cap	4	Rubber "O" ring
2	Rubber plug	5	Camera cable
3	RJ45 enclosure		

This quick start guide provides only basic information on the camera's settings and operation for initial installation. Please read the user manual for optimal camera configurations.

Find the latest product documentation and software.



Scan the QR code or go to openeye.net/downloads



QUICK START GUIDE

4MP Outdoor Mini Dome
OE-C1014D4-S

CONTENTS

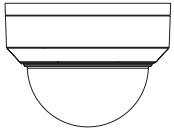

OE-C1014D4-S
Dome Camera

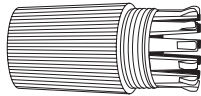

Waterproof Cable
Connector



Self-Tapping
Screws &
Plastic Anchors



Security Torx
Tool

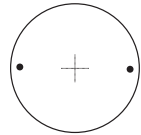

Mounting Template

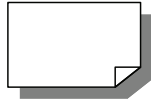

Quick Start
Guide

Optional Free Paintable Dome Cover

This camera has an available paintable dome cover allowing it to be quickly converted to a black housing or the allow custom painting to match its installation environment. To reduce waste it is not included in every package but may be requested free of charge at time of purchase.

INSTALLATION

1. Apply template sticker to desired camera location.
2. Drill anchor holes using included mounting template.
3. Remove mounting template.
4. Insert anchors.
5. Mount camera.
6. Connect network cable with included waterproof cable connector.
7. Adjust camera view.
8. Secure Lid / dome

NOTE: If the camera will be exposed to inclement weather, OpenEye recommends sealing around the camera base, or connection to mounting surface with outdoor waterproof caulking.

DEFAULT USERNAME AND PASSWORD

NOTE: OpenEye IP cameras ship without a default password.

The admin user password can be set using the following methods:

1. OpenEye recorders running Apex 2.6 or newer will automatically set a new unique password when added in setup, if a new password has not already been set.

Set the Default Camera Password

Use the QR code or link for instructions on defining a unique camera password:
https://answers.openeye.net/Install/Adding_Cameras_and_Camera_Settings/Default_Camera_Password



2. Connect to the camera directly through a Web Browser and follow the onscreen prompts.
3. Use the Network Camera Manager (NCM) Utility.

Username: **admin**

ASSIGNING AN IP ADDRESS

OpenEye IP cameras are set to DHCP by default. If a DHCP server is not detected after 2 minutes, the camera will default to IP address 192.168.51.2. If you are not using a DHCP server, NCM will allow you to batch configure a static IP address.

The IP address for the camera network on your Apex recorder is 192.168.51.1.

NOTE: To change this IP address please refer to your Apex recorder manual.

Selecting multiple cameras and entering IP address 192.168.51.2 will set an IP address on all selected cameras, starting at 192.168.51.2 and increase per camera.

1. Open Network Camera Manager.
2. Select applicable camera(s).
3. Input starting IP address, Subnet Mask, Gateway, DNS.
4. Apply changes.
5. Wait 60 seconds before refreshing NCM.

NOTE: The NCM software manual can be found at https://answers.openeye.net/Install/Adding_Cameras_and_Camera_Settings/Network_Camera_Manager

CONNECTING TO THE IP CAMERA

To access the camera setup menu, you need to open Network Camera Manager (NCM) utility. NCM is pre-installed on all OpenEye Recorders, and is also available for download on the OpenEye website for installation on your personal computer or laptop.

1. Open Network Camera Manager.
2. Locate your camera on the Network Camera Manager list.
3. To open the web browser, select the camera and click LOAD.

PRODUCT FEATURES

Camera	
Maximum Resolution	2688x1520
Frame Rate at Maximum Resolution	30FPS @ 4MP H.264/H.265
Total Streams	Dual Streaming
ONVIF	Profile S / G / T Compliant
Day/Night	True Day / Night
Wide Dynamic Range	True WDR

Environmental and Power	
Power Consumption	4.5W Max
Input Voltage	12vDC / PoE
Pan / Tilt / Rotate	Pan: 3° ~ 360°
	Tilt: 0° ~ 68°
	Rotate: 3° ~ 360°
IP Rating	IP67
Impact Rating	IK10