



LINE CROSSING ANALYTICS

Detect a person or vehicle matching specified parameters crossing a user-defined line



PERSON/VEHICLE ANALYTICS

Detect a person or vehicle matching specified parameters entering a user-defined area



CORRIDOR MODE

Optimize monitoring for vertical spaces such as hallways, stairs, tunnels and roads

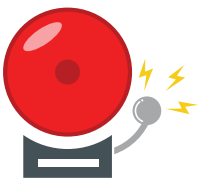

ALARM I/O

Connect external sensors and other devices directly to the camera

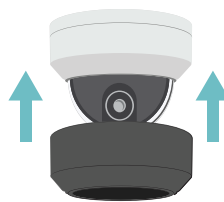

PAINTABLE COVER

Optional snap-on cover is paintable to match the color of its surroundings



TWO-WAY AUDIO

Receive and transmit audio through the camera

CAMERA SPECIFICATIONS

IMAGE	
Image sensor	1/3", 4MP, Progressive Scan, CMOS
Shutter	Auto/Manual; 1 ~ 1/1000000s
Lens	2.7 ~ 13.5mm, VF, AF, Motorized Zoom Lens
Max Resolution	2688x1520
Aspect Ratio	16:9
Field of View	104° ~ 30°
Remote Focus/Zoom	Auto / Manual 4X Optical Zoom
Day/Night	True Day / Night w/ IR-Cut Filter
Wide Dynamic Range (WDR)	True WDR @ 4MP; 120dB
IR	Adaptive IR; up to 131'
Analytics	Person, Vehicle, and Line Crossing Analytics

VIDEO CONTROL	
Video Streams	2
Compression	H.264 / H.265 / MJPEG
Max Frame rate	Primary Stream: 30FPS @ 2688x1520
Day/Night	Auto / Day / Night
White Balance	Auto / Manual / Scene
OSD	Up to 8 OSDs
ROI	Up to 8 areas
Motion Detection	Up to 4 areas
Privacy Masking	Up to 4 areas
Image Rotation	Flip Vertical, Flip Horizontal, 180°, 90° Clockwise, 90° Counter-clockwise

AUDIO	
Audio In/Out	1/1 Built-in mic
Compression	G.711A, G.711U
Two-way audio	Yes
Suppression	Yes

HARDWARE	
Housing / Dome Cover	Metal & Polycarbonate
Dimensions	Ø5.8" x 4.4" (Ø148 x 111mm)
Weight	2lbs (0.92kg)
Alarm In / Relay Out	1/1
Pan / Tilt / Rotate	Pan: 0° ~ 355° Tilt: 0° ~ 80° Rotate: 0° ~ 355°
Country of Origin	China
NDAA Compliant	Yes

CAMERA SPECIFICATIONS (CONTINUED)

NETWORK	
Connector	RJ45
Network	10/100Mbps
ONVIF®	Profile S / G / T Compliant

POWER	
Power Consumption	Max 7W
Power Source	PoE (IEEE 802.3af) / DC 12V±25%

ENVIRONMENTAL	
Operating Environment	-22°F ~ 140°F (-30°C~60°C)
Humidity	95% RH (non-condensing)

STORAGE	
Onboard Storage	MicroSD card; Up to 512GB
Network	Supported

CERTIFICATIONS	
Certifications	UL / CE / FCC Class A

DIMENSIONS

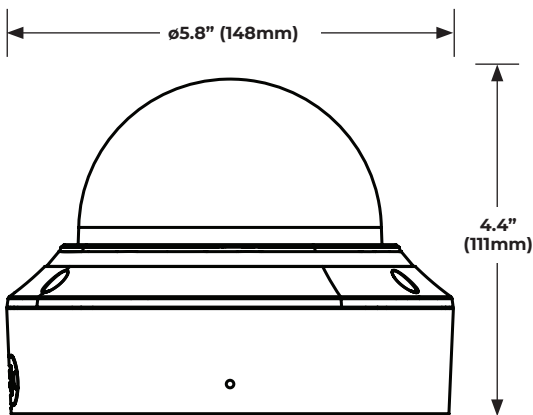

CONNECTIONS

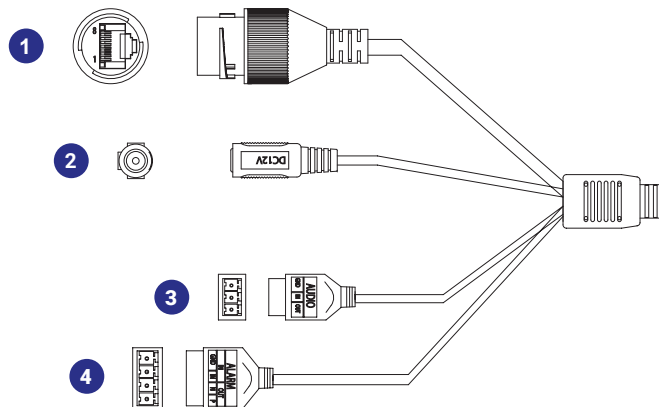

1	RJ-45	For network and PoE connections
2	Power (12VDC)*	Power connection
3	Audio I/O	Ground
		Audio In
		Audio Out
4	Alarm I/O	Ground
		Audio In
		Alarm Out -
		Alarm Out +

*12VDC power input port should be plugged when not in use.

ACCESSORIES



32-Series Junction Box
OE-CA32JB-01

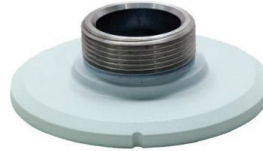

32-Series Pendant Cap
OE-CA32PC-01



32-Series Wall Mount
OE-CA32WM-01



32-Series Transfer Plate
OE-CA32TP-01



32-Series In-Ceiling Mount
OE-CA32ICM-01



Paintable Dome Cover
OE-CA32PDC-01



32-Series Wall Mount
OE-CA32WM-01

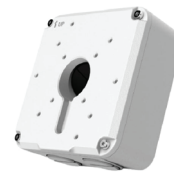

Indoor/Outdoor 7" Junction Box
OE-CA00JB-01



32-Series Wall Mount
OE-CA32WM-01

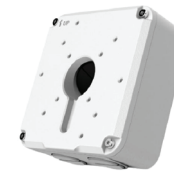

Indoor/Outdoor 7" Junction Box
OE-CA00JB-01



Pole Mount Kit
OE-CA00PMK-01

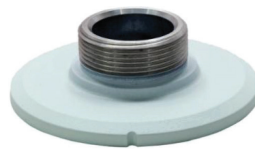

32-Series Pendant Cap
OE-CA32PC-01



Indoor/Outdoor Wall Mount
OE-CA00WM-01

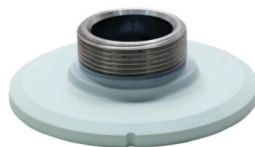

32-Series Pendant Cap
OE-CA32PC-01



Indoor/Outdoor Wall Mount
OE-CA00WM-01



Corner Mount
OE-CA00CM-01

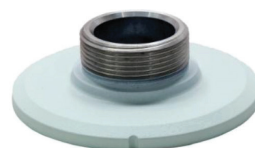

32-Series Pendant Cap
OE-CA32PC-01



Indoor/Outdoor Wall Mount
OE-CA00WM-01



Pole Mount Kit
OE-CA00PMK-02

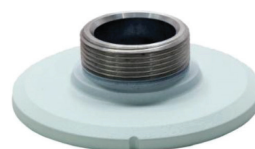

32-Series Pendant Cap
OE-CA32PC-01



Ceiling-Mounted Pole
OE-CA00CMP-01